

EXTECH[®]
INSTRUMENTS

USER GUIDE

3000A TRUE RMS AC Flexible Clamp Meters
Model MA3010 and MA3018

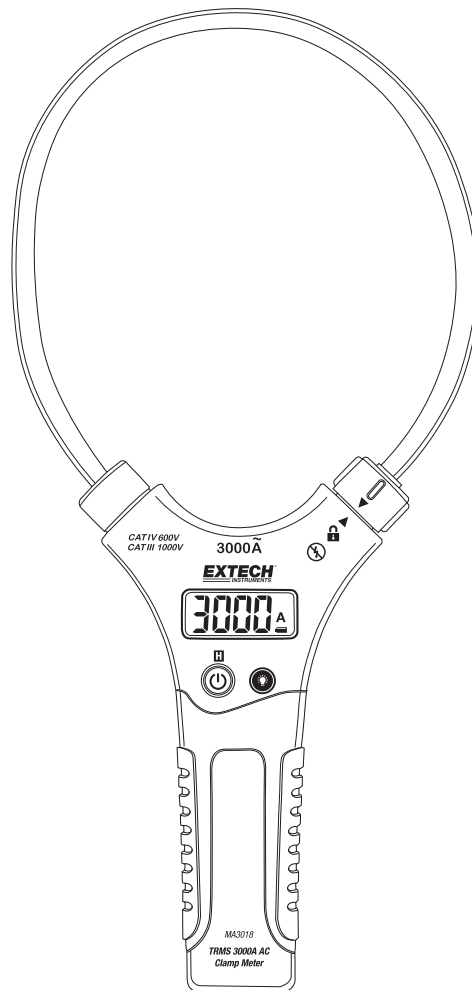

Introduction

Thank you for choosing the Extech AC Flexible Clamp meter that can measure up to 3000A AC rms. The MA3018 is the 18" (45.7cm) clamp version and the MA3010 is the 10" (25.4cm) clamp version, otherwise both meters are the same. These devices are professional CAT IV 600V CAT III 1000V instruments that offer Auto Power OFF, Data Hold, and backlight features. This meter is shipped fully tested and calibrated and, with proper use, will provide years of reliable service.

Features

- 3000A AC True RMS Current Measurements
- Auto Range
- 3000 count large scale backlit LCD display
- Convenient Flexible Clamp with locking mechanism
- 7.5mm (0.3") coil diameter for measuring in tight spaces
- Data Hold
- Auto Power OFF
- Battery status icon and Battery status power on alert
- Long life battery power

Safety Information

To ensure the safe operation and service of the meter, follow these instructions closely. Failure to observe warnings can result in severe injury.



WARNINGS









WARNINGS identify hazardous conditions and actions that could cause BODILY HARM or DEATH.

- Individual protective equipment should be used if HAZARDOUS LIVE parts in the installation where measurements are to be carried out could be accessible.
- If the equipment is used in a manner not specified by the manufacturer, the protection provided by the equipment may be impaired.
- To reduce the risk of fire or electric shock, do not expose this product to rain or moisture.
- Verify the meter operation by measuring a known current. If in doubt, have the meter serviced.
- Do not apply more than the rated voltage/current as marked on the meter.
- To avoid false readings that can lead to electric shock and injury, replace battery as soon as the low battery indicator appears.
- Do not use the meter in or around explosive gas or vapor.
- Do not use a flexible current sensor if the inner copper wire of the flexible cord is visible.
- De-energize the installation under test or wear suitable protective clothing when placing or removing the flexible current probe from a test setup.
- Do not apply/remove the flexible current probe to/from UNINSULATED HAZARDOUS LIVE conductors which may cause electric shock, electric burn, or arc flash.

 **CAUTIONS**

CAUTIONS identify conditions and actions that could cause DAMAGE to the meter or equipment under test. Do not expose the meter to extremes in temperature or high humidity.

Safety Symbols that are typically marked on meters and instructions

	This symbol, adjacent to another symbol, indicates the user must refer to the manual for further information.
	Do not apply or remove clamp from HAZARDOUS LIVE conductors
	Equipment protected by double or reinforced insulation
	Battery symbol
	Conforms to EU directives
	Do not discard this product in household trash.
	AC measurement
	Earth ground

PER IEC1010 OVERVOLTAGE INSTALLATION CATEGORY

OVERVOLTAGE CATEGORY I

Equipment of OVERVOLTAGE CATEGORY I is equipment for connection to circuits in which measures are taken to limit the transient over-voltages to an appropriate low level.

Note – Examples include protected electronic circuits.

OVERVOLTAGE CATEGORY II

Equipment of OVERVOLTAGE CATEGORY II is energy-consuming equipment to be supplied from the fixed installation.

Note – Examples include household, office, and laboratory appliances.

OVERVOLTAGE CATEGORY III

Equipment of OVERVOLTAGE CATEGORY III is equipment in fixed installations.

Note – Examples include switches in the fixed installation and some equipment for industrial use with permanent connection to the fixed installation.

OVERVOLTAGE CATEGORY IV

Equipment of OVERVOLTAGE CATEGORY IV is for use at the origin of the installation.

Note – Examples include electricity meters and primary over-current protection equipment

Description

Meter Description

1. Flexible Current Clamp
2. Power-Hold button
3. Battery Compartment
4. Backlight button
5. LCD display
6. Clamp Lock mechanism

Display Icons

HOLD	Data Hold
A	Amperes (Current)
-	Minus symbol (negative)
FULL	Battery status message (on power up)
	Battery status icon
3000	3000 count reading display

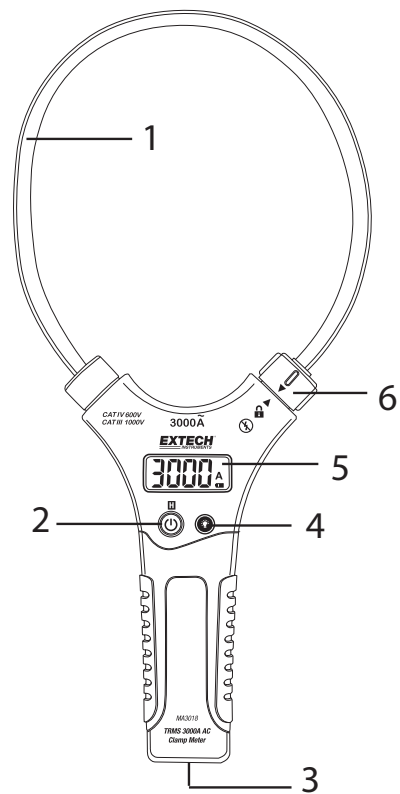

Operation

NOTES: Read and understand all **Warning** and **Caution** statements in this operation manual prior to using this meter.

Meter Power

The meter is powered by two (2) AAA 1.5V batteries (located in compartment on bottom of meter handle). Press and hold the Power button for > 2 seconds to switch the device ON or OFF.

When the meter switches ON the display shows the battery status (FULL, for example). There is also a battery status icon displayed on the lower right hand corner of the LCD.

Low battery indication

When the displayed battery icon appears empty or if the power ON battery status message indicates weak battery power, the batteries should be replaced immediately. Refer to the battery replacement procedure in the maintenance section.

Automatic Power OFF

The meter switches OFF automatically after a 20 minute period of inactivity (± 30 seconds). To disable the Auto Power OFF feature:

- With the meter power OFF, press and hold the Power button for >2 seconds
- When the display shows the battery status (FULL, for example), press the backlight button until the display shows 'AoFF'.
- The APO feature is now disabled and the meter will not shut off automatically.
- Note that the next time the meter is powered up, the Auto Power OFF function will be re-enabled and the user will have to repeat the Auto Power OFF disable instructions to disable this function when desired.

Backlit LCD

Press the backlight button to switch the LCD backlight ON or OFF. Note that excessive use of the backlight feature will shorten battery life.

Data Hold

Press the HOLD button with the meter ON to freeze the displayed reading. The HOLD icon will appear along with the held reading. Press the HOLD button again to release the HOLD feature. The HOLD icon will switch OFF and the meter will show real time readings.

AC Current Measurements

WARNING: Ensure that power to the device under test is OFF before starting this procedure. Switch power to the device under test ON only after the clamp has been safely attached to the device under test.



CATUTION: Do not move fingers above the LCD at any time during a test.

1. Switch the meter OFF and switch OFF power to the device under test.
2. Turn the knurled clamp lock mechanism counter-clockwise to release the flexible clamp.
3. Fully enclose only one conductor of the device under test with the flexible clamp probe (see accompanying diagrams). Do not attempt to measure current higher than the specified current limit.
4. Switch the meter ON and then switch power to the device under test ON. Never move fingers above the LCD when running a test.
5. Read the current value in the display. The meter will automatically select the appropriate range.

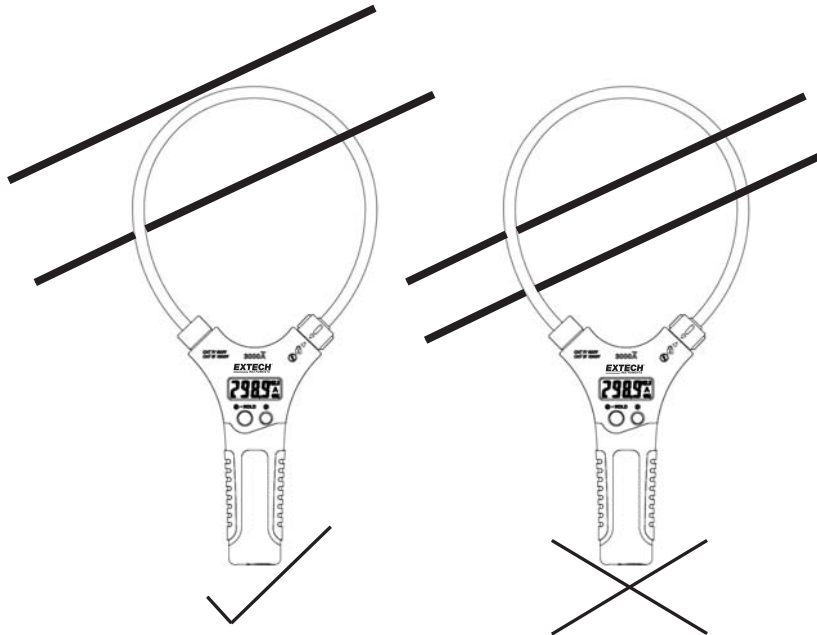

Maintenance

WARNING: To avoid electrical shock, disconnect the meter from any circuit and turn OFF the meter before opening the case. Do not operate the meter with an open case.

Cleaning and Storage

Periodically wipe the case with a damp cloth and mild detergent; do not use abrasives or solvents. If the meter is not to be used for 60 days or more, remove the batteries and store them separately.

Battery Replacement

 **CAUTION:** Remove the meter from the conductor under test and switch the meter OFF before opening the battery compartment.

1. With a flat blade screwdriver or coin, rotate the battery compartment cover to the unlock position.
2. Remove the battery compartment cover.
3. Replace the 2 'AAA' 1.5V batteries observing correct polarity.
4. Re-attach the battery compartment cover.
5. Rotate the battery compartment cover to the lock position.



You, as the end user, are legally bound (**EU Battery ordinance**) to return all used batteries, **disposal in the household garbage is prohibited!** You can hand over your used batteries / accumulators at collection points in your community or wherever batteries accumulators are sold!

Disposal: Follow the valid legal stipulations in respect of the disposal of the device at the end of its lifecycle

Specifications

Function	Range	Overload Reading (OL)	Resolution	Accuracy (45 to 500Hz)
AC Current	30.00 A AC	33.00 A AC	0.01A	±(3.0% + 5 digits)
	300.0A AC	330.0 A AC	0.1A	±(3.0% + 5 digits)
	3000 A AC	3300 A AC	1A	±(3.0% + 5 digits)

Notes:

Accuracy is given as ± (% of reading + least significant counts) at 23C ±5C with relative humidity lower than 80%. Accuracy is specified for a period of one year after calibration.

Position Error of Clamp: Accuracy and position error assumes centralized primary conductor at optimum position, no external electrical or magnetic field, and within operating temperature range.

	MA3010	MA3010 Error*	MA3018	MA3018 Error*
Distance from optimum position	15mm (0.6")	+2.0%	35mm (1.4")	+1.0%
	25mm (1.0")	+2.5%	50mm (2.0")	+1.5%
	35mm (1.4")	+3.0%	60mm (2.4")	+2.0%

*Add this error to the AC Current accuracy specification listed earlier in this section.

LCD displays '0' counts when the reading is < 10 counts.

ACA specifications are AC Coupled, True RMS.

For non-sinusoidal waveforms, additional accuracy Crest Factor (C.F.) considerations exist as detailed below:

Add 3.0% for C.F. 1.0~2.0

Add 5.0% for C.F. 2.0~2.5

Add 7.0% for C.F. 2.5~3.0

GENERAL SPECIFICATIONS

Clamp Jaw	Flexible type with locking mechanism and 7.5mm (0.3") coil diameter
Display	3000 count LCD with backlight and multi-function indicators
Low Battery indication	Battery symbol is displayed and text alert is shown upon power up
Over-range indication	'OL' display
Measurement conversion rate	4 times per second
AC bandwidth	45 to 500Hz (sine wave)
AC response	True RMS
Operating Temperature and Humidity	0~30°C (32~86°F); 80%RH maximum 30~40°C (86~104°F); 75%RH maximum 40~50°C (104~122°F); 45%RH maximum
Storage Temperature and Humidity	-20~60°C (-4~140°F); 80%RH maximum
Temperature Coefficient	0.2 x specified accuracy / °C, < 18°C (64.5°F), > 28°C (82.4°F)
Altitude	Maximum operating altitude 2000m (6562')
Battery	Two "AAA" 1.5V batteries
Battery life	200 hours with alkaline batteries
Auto power OFF	After approx. 20 minutes of inactivity
Dimensions (W x H x D)	MA3010: 120 x 280 x 25 mm (4.7 x 11.0 x 1.0") MA3018: 130 x 350 x 25 mm (5.1 x 13.8 x 1.0")
Weight	MA3010: 170g (6.0 oz.) / MA3018: 200g (7.1 oz.)
Safety Standards	For indoor use and in accordance with the requirements for double insulation to EN61010-1, EN61010-2-032, EN61326-1; CAT IV 600V, CAT III 1000V, Pollution Degree 2
Shock Vibration	Sinusoidal vibration MIL-PRF-28800F (5-55 Hz, 3g max.)
Drop Protection	1.2m (4') drop onto hardwood or concrete flooring

Copyright © 2015 FLIR Systems, Inc.

Reservados todos los derechos, incluyendo el derecho de reproducción total o parcial en cualquier medio

www.extech.com