

Flowmeter with paddle-wheel for continuous flow measurement



- Economic integration in pipe systems without any additional piping
- Magnetic measuring principle (paddle wheel with hall sensor)
- Output: transistor output (frequency signal)

Type 8011 can be combined with



Type 8619

Multifunction transmitter/controller



Type 2301 (8692/8693)

TopControl System



Type 8611

Universal Controller eControl



Type 8032

Flow controller

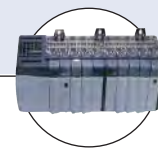

PLC

The paddle wheel flowmeter for continuous flow measurement is especially designed for use in neutral, slightly aggressive, solid free liquids. The 8011 is made up of a fitting (S012) and an electronic module (SE11) connected together with screws. The Bürkert designed fitting system ensures simple installation into all pipes from DN06 to DN65. It can also be installed in fluid block systems.

The 8011 produces a frequency signal, proportional to the flow rate, which can be processed by a Bürkert remote transmitter/controller.

The 8011 is available in two versions:

- with one pulse output: transistor NPN
- with two pulse outputs: transistor NPN and PNP.

General data	
Compatibility	with fittings S012 (see ordering chart)
Fitting process connections	Internal or external thread (weld ends, clamp or flange on request) True union or external thread (spigot on request)
Materials	PPS / EPDM PA PVC
Housing / Seal	
M12 fixed connector, cable gland	
1 meter cable	
Wetted parts materials	Brass, stainless steel 1.4404/316L, PVC, PP
Fitting	PVDF blue / PVDF
Paddle wheel / Holder	Ceramics (AL ₂ O ₃) / FKM (EPDM option)
Axis and bearing / Seal	
Electrical connection	Fixed connector 5-pin M12 (or with 1 m cable via cable gland, on request)
Connection cable	1.5 mm ² max. cross-section
Complete device data (fitting + electronic module)	
Pipe diameter	DN06...DN50 (DN65 on request)
Measuring range	0.3...10 m/s
Measuring element	magnetic hall sensor
Medium temperature with	0...+60°C / 0...+80°C
PVC fitting / PP fitting	-15...+100°C (if T ^{ambient} ≤ 45°C) or
Stainless steel, brass fitting	-15...+90°C (if 45°C ≤ T ^{ambient} ≤ 60°C)
Fluid pressure max.	PN10 (with plastic fitting) PN16 (with metal fitting)
Viscosity / Pollution	max. 300 cSt. / max. 1% (size of particles 0.5 mm max.)
Measurement deviation	±1% of Reading ¹⁾ (at the teach flow rate value) ±2.5% of Reading ¹⁾
Teach-In	
Standard K-factor	
Linearity	±0.5% of FS.*
Repeatability	±0.4% of Reading ¹⁾

* FS. = Full scale (10 m/s)

¹⁾ Under reference conditions i.e. measuring fluid = water, ambient and water temperature = 20°C, applying the minimum inlet and outlet pipe straights, matched inside pipe dimensions.

Electrical data	
Operating voltage (V+)	4.5...24 V DC, filtered and regulated
One pulse output version	4.5...24 V DC, filtered and regulated
Two pulse outputs version	6...36 V DC, filtered and regulated
Current consumption	< 5 mA (without load)
Reversed polarity of DC	Protected
Voltage peak	Protected
Short circuit	Protected for transistor output
Output	
One pulse output version	Transistor NPN open collector, max. 20 mA, NPN output: 0.2...24 V DC, frequency up to 300 Hz (Frequency [Hz] = K factor [pulse/litre] x flow rate [l/s])
Two pulse outputs version	Transistor NPN and PNP open collector, max. 700 mA, NPN output: 0.2...36 V DC, PNP output: operating voltage, frequency up to 300 Hz (Frequency [Hz] = K factor [pulse/litre] x flow rate [l/s])
Environment	
Ambient temperature	-15...+60°C (operating and storage)
Relative humidity	≤ 80%, without condensation
Standards, directives and certifications	
Protection class	IP67 with multipin M12 (IP65 with cable)
Standard and directives CE	The applied standards, which verify conformity with the EU Directives, can be found on the EU Type Examination Certificate and/or the EU Declaration of conformity (if applicable)
Pressure	Complying with article 4, §1 of 2014/68/EU directive*
Certifications / Certificates on request	Inspection certificate 3.1 (acc. to EN-ISO 10204); Test report 2.2 (acc. to EN-ISO 10204); Certification of Conformity for the surface Quality (DIN4762-DIN4768-ISO/4287/1); 3 points Flow calibration certificate

* For the 2014/68/EU pressure directive, the device can only be used under following conditions (depending on max. pressure, pipe diameter and fluid).

Type of fluid	Conditions
Fluid group 1, article 4, §1.c.i	DN ≤ 25
Fluid group 2, article 4, §1.c.i	DN ≤ 32 or PN*DN ≤ 1000
Fluid group 1, article 4, §1.c.ii	DN ≤ 25 or PN*DN ≤ 2000
Fluid group 2, article 4, §1.c.ii	DN ≤ 200 or PN ≤ 10 or PN*DN ≤ 5000

Pressure/temperature diagram

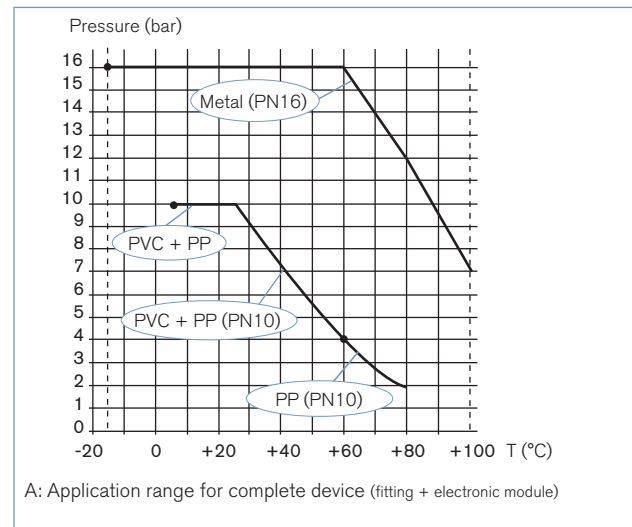

Main features

8011 with magnetic principle Version with Transistor output

- ▶ Transistor output: NPN or NPN/PNP operation.
- ▶ With one transistor output
 - Raw frequency (2 pulses per paddle wheel rotation)

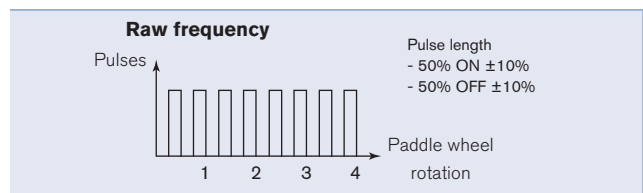

Design and principle of operation

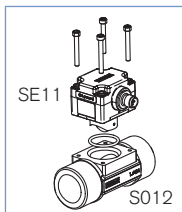

The flowmeter 8011 is built up with an electronic module and a measurement paddle wheel associated to a fitting. This connection is made by means of screws.

When liquid flows through the pipe, the paddle wheel is set in rotation. The non-wetted permanent magnets inserted in the paddle wheel generate a measuring signal which frequency is proportional to the flow velocity. It is designed for connection to any system with open collector NPN or PNP frequency input. The output signal is provided via a 5-pin M12 fixed connector (or a cable gland with 1 m-length cable on request).

Installation

Minimum straight inlet and outlet distances must be observed. According to the pipes design, necessary distances can be bigger or use a flow conditioner to obtain the best results. The most important layouts that could lead to turbulence in the flow are shown below, together with the associated prescribed minimum inlet and outlet distances determined according to the standard EN ISO 5167-1

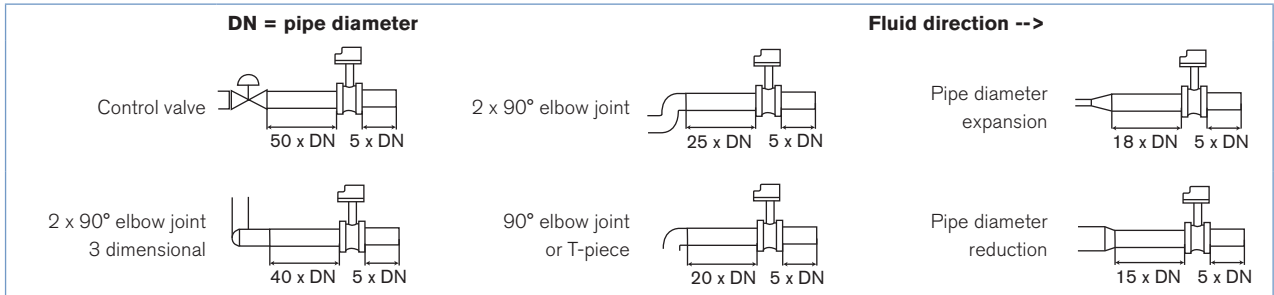

The flowmeter can be installed in either horizontal or vertical pipes, but following additional conditions should be respected

- always install the 8011 so that the paddle wheel axis is horizontal
- ensure the pipe is maintained full at all times, near the device
- ensure the pipe design does not allow the build-up of air bubbles or cavities within the medium, near the device

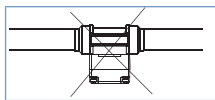
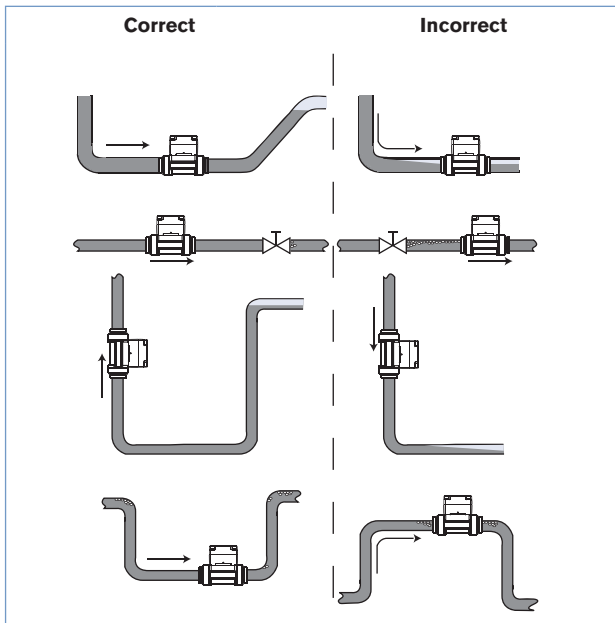

When installing the 8011 on an horizontal pipe, make sure the paddle wheel is oriented down.

Pressure and temperature ratings must be respected according to the selected fitting material. The suitable pipe size is selected using the diagram Flow/Velocity/DN. The measuring device is not designed for gas flow measurement.

Diagram Flow/Velocity/DN

Example:

- Flow: 10 m³/h
- Ideal flow velocity: 2...3 m/s

For these specifications, the diagram indicates a pipe size of DN40 [or DN50 for (*) mentioned fittings]

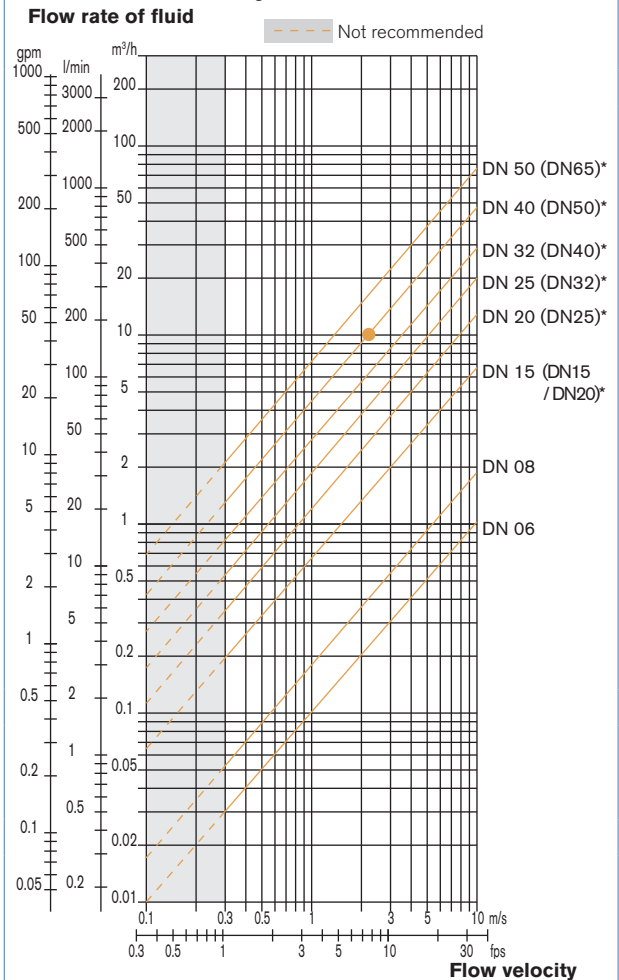

- * for following fittings with:
- external threads acc. to SMS 1145
 - weld ends acc. to SMS 3008, BS4825-1/ASME BPE/DIN 11866 series C or DIN 11850 series 2/DIN 11866 series A/DIN EN 10357 series A
 - Clamp acc. to SMS 3017, BS 4825-3/ASME BPE or DIN 32676 series A

Dimensions [mm] electronic module

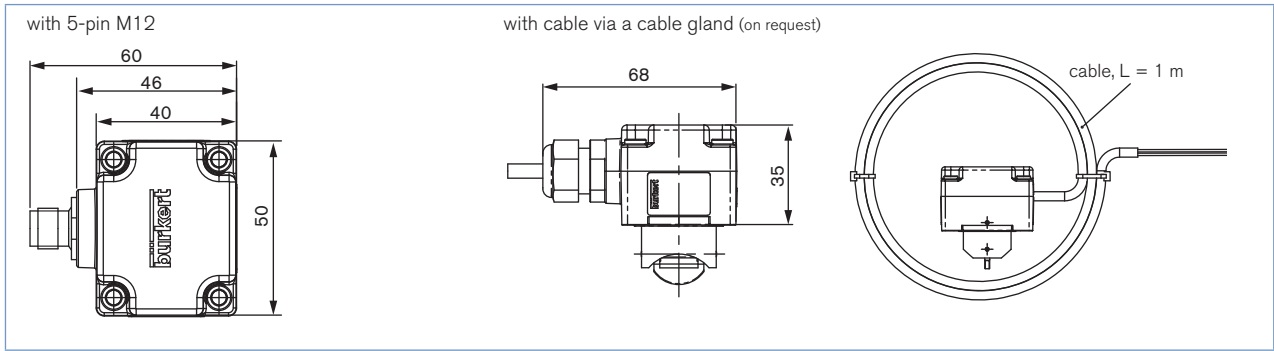

Dimensions 8011

8011 with internal thread connection

G, NPT or Rc
in stainless steel (316L - 1.4404) or
brass (CuZn39Pb2)

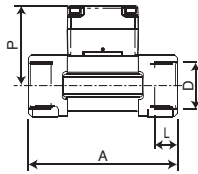

DN [mm]	P [mm]	A [mm]	D [inch]	L [mm]
15	57.5	84.0	G 1/2	16.0
			NPT 1/2	17.0
			Rc 1/2	15.0
20	55.0	94.0	G 3/4	17.0
			NPT 3/4	18.3
			Rc 3/4	16.3
25	55.2	104.0	G 1	23.5
			NPT 1	18.0
			Rc 1	18.0
32	58.8	119.0	G 1 1/4	23.5
			NPT 1 1/4	21.0
			Rc 1 1/4	21.0
40	62.6	129.0	G 1 1/2	23.5
			NPT 1 1/2	20.0
			Rc 1 1/2	19.0
50	68.7	148.5	G 2	27.5
			NPT 2	24.0
			Rc 2	24.0

8011 with external thread connection

G, NPT or Rc
in stainless steel (316L - 1.4404),
brass (CuZn39Pb2)
or PVC

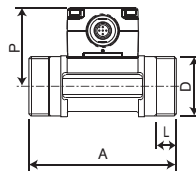

DN [mm]	P [mm]	A [mm]	D [inch]	[mm]	L [mm]
06	52.5	90.0	G 1/2	-	14.0
08	52.5	90.0	** 1/2	M 16 x 1.5	14.0

** G, NPT, RC according to fitting version

8011 with True union connection

DIN 8063, ASTM D 1785/76 or JIS K in PVC

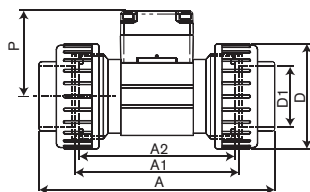

DN [mm]	P [mm]	D [mm]	A [mm]	ASTM [mm]	JIS [mm]	D1 [mm]	ASTM [mm]	JIS [mm]	A2 [mm]	A1 [mm]
15	57.5	43	128	130.0	129	20	21.3	18.40	90	96
20	55.0	53	144	145.6	145	25	26.7	26.45	100	106
25	55.2	60	160	161.4	161	32	33.4	32.55	110	116
32	58.8	74	168	170.0	169	40	42.2	38.60	110	116
40	62.6	83	188	190.2	190	50	48.3	48.70	120	127
50	68.7	103	212	213.6	213	63	60.3	60.80	130	136

Ordering chart for 8011, 4.5...24 V DC, 5-pin M12, NPN output

! Two versions of the fitting in DN15 and DN20 exist, having different K factors.

Only version 2, identified by the "v2" marking, is available from March 2012. The "v2" marking can be found:

- on the bottom of the DN15 or DN20 fitting in plastic:



- on the side of the DN15 or DN20 fitting in metal:



Process connection	Standard	Output	Item no.								
			DN06 - 1/4"	DN06 - 1/2"	DN08 - 1/2"	DN15	DN20	DN25	DN32	DN40	DN50
Brass - Medium temperature max. 100°C, PN16											
Internal thread	G	Pulse NPN	-	-	-	559 918	559 919	559 920	559 921	559 922	559 923
	NPT	Pulse NPN	-	-	-	559 924	559 925	559 926	559 927	559 928	559 929
	Rc	Pulse NPN	-	-	-	559 930	559 931	559 932	559 933	559 934	559 935
External thread	G	Pulse NPN	559 915	559 916	559 917	-	-	-	-	-	-
Stainless steel - Medium temperature max. 100°C, PN16											
Internal thread	G	Pulse NPN	-	-	-	559 939	559 940	559 941	559 942	559 943	559 944
	NPT	Pulse NPN	-	-	-	559 946	559 947	559 948	559 949	559 950	559 951
	Rc	Pulse NPN	-	-	-	559 952	559 953	559 954	559 955	559 956	559 957
External thread	G	Pulse NPN	559 936	559 937	559 938	-	-	-	-	-	-
	NPT	Pulse NPN	-	-	559 945	-	-	-	-	-	-
PVC - Medium temperature max. 60°C, PN10											
True union	DIN	Pulse NPN	-	-	-	559 960	559 961	559 962	559 963	559 964	559 965
	ASTM	Pulse NPN	-	-	-	559 966	559 967	559 968	559 969	559 970	559 971
	JIS	Pulse NPN	-	-	-	559 972	559 973	559 974	559 975	559 976	559 977
External thread	G	Pulse NPN	-	559 958	559 959	-	-	-	-	-	-

Further versions on request



Port connection

Weld ends SMS 3008, BS 4825-1/ASME BPE/DIN 11866 series C or DIN 11850 series 2/DIN 11866 series A/ DIN EN 10357 series A
 Clamp DIN 32676 series B, SMS 3017, BS 4825-3/ASME BPE or DIN 32676 series A
 Flange EN1092-1/B1/PN16, ANSI B16-5 or JIS 10K
 True union ISO 10931
 Spigot ISO 10931



Materials

Fitting: PVC, PP,
 Seal: EPDM
 Special surface finish



Electrical connection

with 1 m cable



Additional

Two pulse NPN/PNP outputs

Please also use the "request for quotation" form on page 8 for ordering further versions of the 8011 [go to page](#)

Ordering chart for accessories for 8011 (to be ordered separately)

Specification	Item no.							
	DN06	DN08	DN15	DN20	DN25	DN32	DN40	DN50
4 short screws (M4 x 35 - A4) + 4 long screws (M4 x 60 - A4)	555 775							
5-pin M12 female connector moulded on cable (2 m, shielded)	438 680							
5-pin M12 female connector with plastic threaded locking ring	917 116							
Specification	Item no.							
	DN06	DN08	DN15	DN20	DN25	DN32	DN40	DN50
O-ring set for metal fitting - FKM	426 340	426 340	426 340	426 340	426 340	426 340	426 340	426 340
O-ring set for metal fitting - EPDM	426 341	426 341	426 341	426 341	426 341	426 341	426 341	426 341
O-ring set for plastic fitting - FKM	-	448 679	431 555	431 556	431 557	431 558	431 559	431 560
O-ring set for plastic fitting - EPDM	-	448 680	431 561	431 562	431 563	431 564	431 565	431 566

Variants of flowmeter Type 8011

A flowmeter Type 8011 consists of:

- an electronic module SE11 with magnetic measuring principle, with pulse output. The electrical connection is carried out through a 5-pin M12 fixed connector or a 1 m cable.
- a fitting Type S012 available in different materials providing many installation options of the electronic module into all pipes, ranging from DN06 to DN65, due to the large range of process connections (see specification sheet on last page).
- screws and O-ring (see ordering chart for accessories).

The following charts indicate the different variants:

Electronic module Type SE11

Specification	Pipe connection	Operating voltage	Output*	Connection	Item no.
Magnetic measuring principle	DN06, DN08, DN15 v2 and DN20 v2	4.5...24 V DC	Frequency with pulse NPN	5-pin M12 fixed connector with 1 m cable	559 440
			Frequency with pulse NPN		559 442
		6...36 V DC	Frequency with pulse NPN/PNP	5-pin M12 fixed connector with 1 m cable	559 441
			Frequency with pulse NPN/PNP		559 443
	DN15...DN50 (except DN15 v2 and DN20 v2)	4.5...24 V DC	Frequency with pulse NPN	5-pin M12 fixed connector with 1 m cable	559 444
			Frequency with pulse NPN		559 446
6...36 V DC	Frequency with pulse NPN/PNP	5-pin M12 fixed connector with 1 m cable	559 445		
	Frequency with pulse NPN/PNP		559 447		

Fitting Type S012 (possibilities versions - ⚠ can not be ordered separately)

Port connection	Materials	Available									
		DN06	DN08	DN15	DN20	DN25	DN32	DN40	DN50	DN65	
Internal thread	Brass, stainless steel	-	-	Yes	Yes	Yes	Yes	Yes	Yes	Yes	-
External thread	Brass, stainless steel, PVC, PP	Yes	Yes	Yes	Yes	Yes	Yes	Yes	Yes	Yes	-
	Stainless steel acc. SMS 1145	-	-	-	-	Yes	-	Yes	Yes	Yes	-
Weld ends	Stainless steel	-	Yes	Yes	Yes	Yes	Yes	Yes	Yes	Yes	Yes
Clamp	Stainless steel	-	Yes	Yes	Yes	Yes	Yes	Yes	Yes	Yes	Yes
Flange	Stainless steel	-	-	Yes	Yes	Yes	Yes	Yes	Yes	Yes	-
True union	PVC	-	Yes	Yes	Yes	Yes	Yes	Yes	Yes	Yes	-
	PP	-	-	Yes	Yes	Yes	Yes	Yes	Yes	Yes	-
Spigot	PVC, PP	-	-	Yes	Yes	Yes	Yes	Yes	Yes	Yes	-

⚠ Fitting in PVDF not available.

Interconnection possibilities with the 8011

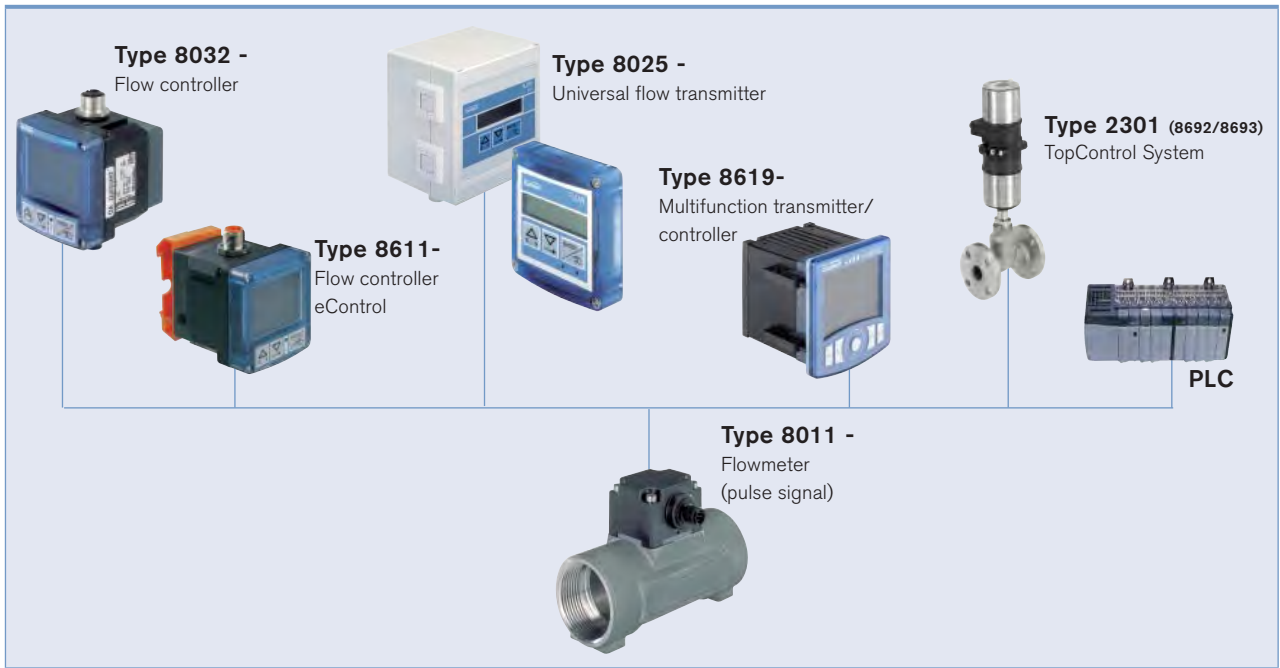

Fluid block system using Type 8011

The modular concept of the electronic module Type SE11 allows fully customized, pre-mounted and tested solutions to completely meet application needs. It is designed for being mounted in a system block, associated with other Bürkert products. This allows cost reduction and compact design for customized solutions.

Please contact your Bürkert local office to have individual counselling and engineering support in order to find the best solution corresponding to your application.

Example of flow control systems with SE11 electronic module

Cooling of molding tools in plastic injection machines

Flow (8011) + temperature + manual On/Off valve

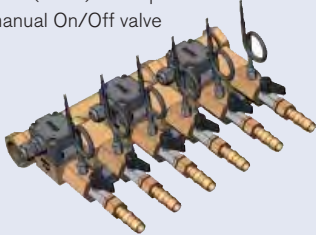

Cooling of welding robot in automotive industry

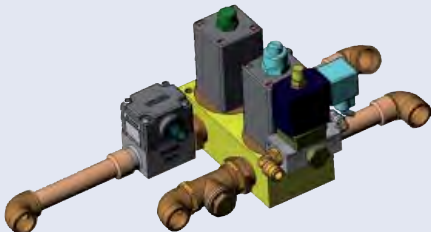

Flow (8011) + pilot valve (6014) + On/Off diaphragm valve (0263)

On/Off control loop

Valve island AirLine Type 8644

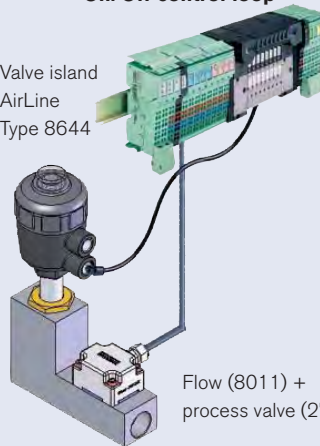

Flow (8011) + process valve (2712)

Filter monitoring in waste water treatment



Flow (8011) + pressure (8316)

Flow regulation in Ro water treatment skid



Process valve (2712 + 8692) + Flow (8011)

Flowmeter 8011 - request for quotation

Please fill in and send to your local Bürkert Sales Centre with your inquiry or order.

Note
You can fill out the fields directly in the PDF file before printing out the form.

Company:	Contact person:
Customer No.:	Department:
Address:	Tel. / Fax.:
Postcode / Town:	E-mail:

Flowmeter 8011	Quantity: <input type="text"/>	Desired delivery date: <input type="text"/>
Fitting S012		
■ Pipe diameter DN <input type="checkbox"/> 6 <input type="checkbox"/> 8 <input type="checkbox"/> 15 <input type="checkbox"/> 20 <input type="checkbox"/> 25 <input type="checkbox"/> 32 <input type="checkbox"/> 40 <input type="checkbox"/> 50 <input type="checkbox"/> 65		
■ Materials: Body <input type="checkbox"/> Brass <input type="checkbox"/> Stainless steel <input type="checkbox"/> PVC <input type="checkbox"/> PP		
Seal <input type="checkbox"/> FKM <input type="checkbox"/> EPDM		
■ Process connection: Internal thread <input type="checkbox"/> G <input type="checkbox"/> NPT <input type="checkbox"/> Rc		
External thread <input type="checkbox"/> G <input type="checkbox"/> NPT <input type="checkbox"/> Rc		
Weld ends <input type="checkbox"/> EN ISO1127/ISO4200/DIN 11866 series B <input type="checkbox"/> DIN 11850 series 2/DIN 11866 series A/DIN 10357 series A <input type="checkbox"/> SMS 3008		
Clamp <input type="checkbox"/> DIN 32676 series B <input type="checkbox"/> BS4825-3/ASME BPE <input type="checkbox"/> SMS 3017		
Flange <input type="checkbox"/> EN1092-1/B1/PN16 <input type="checkbox"/> ANSI B16-5 <input type="checkbox"/> DIN 32676 series A		
True union <input type="checkbox"/> DIN 8063 <input type="checkbox"/> ASTM <input type="checkbox"/> JIS 10K		
Spigot <input type="checkbox"/> DIN 8063 <input type="checkbox"/> DIN 16962 <input type="checkbox"/> JIS		
■ Special surface finish <input type="checkbox"/> without <input type="checkbox"/> with Ra int. = <input type="text"/> Ra ext. = <input type="text"/>		
Electronic module SE11		
■ Electrical connection <input type="checkbox"/> Multipin M12 <input type="checkbox"/> with 1 m cable		
1. Transistor output feature		
■ Transistor operation* <input type="checkbox"/> NPN <input type="checkbox"/> NPN/PNP		
<div style="border: 1px dashed gray; padding: 5px; display: inline-block;">Reset form</div>		

* Refer to electrical features for operating voltage and current limits

To find your nearest Bürkert facility, click on the orange box →

www.burkert.com

In case of special application conditions, please consult for advice.

Subject to alteration.
© Christian Bürkert GmbH & Co. KG

1607/16_EU-en_00891979

DTS 1000102447 EN Version: P Status: RL (released | freigegeben | valide) printed: 24.10.2016