

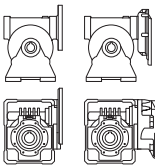

25 MOMENT OF INERTIA

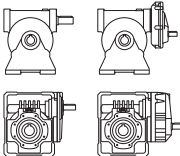

The following charts indicate the mass moment of inertia J_r [Kgm²] referred to gear unit with high speed solid shaft. A key to the symbols used follows:

	<p>Values of the moment of inertia refer to compact gearmotors, less the motor inertia. To obtain the overall moment of inertia for the gearmotor just add the value of the inertia for the specific compact motor, given in the relevant rating chart.</p>		<p>Values refer to gearmotors, IEC style, less the motor.</p>
			<p>Values refer to speed reducers (solid input shaft).</p>

VF 27



		i	J (•10 ⁻⁴) [kgm ²]				
			P27				
VF 27	VF 27_7	7	0.02	—	—	—	0.02
	VF 27_10	10	0.01	—	—	—	0.01
	VF 27_15	15	0.01	—	—	—	0.01
	VF 27_20	20	0.01	—	—	—	0.01
	VF 27_30	30	0.01	—	—	—	0.01
	VF 27_40	40	0.01	—	—	—	0.01
	VF 27_60	60	0.01	—	—	—	0.01
	VF 27_70	70	0.01	—	—	—	0.01

VF 30

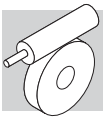
		i	J (•10 ⁻⁴) [kgm ²]				
			P56	P63			
VF 30	VF 30_7	7	0.08	0.07	—	—	0.04
	VF 30_10	10	0.07	0.06	—	—	0.03
	VF 30_15	15	0.07	0.06	—	—	0.03
	VF 30_20	20	0.06	0.06	—	—	0.03
	VF 30_30	30	0.06	0.06	—	—	0.03
	VF 30_40	40	0.06	0.06	—	—	0.03
	VF 30_60	60	0.06	0.05	—	—	0.02
	VF 30_70	70	0.06	—	—	—	0.02



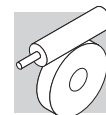

VF 44 - VFR 44

		i	J ($\cdot 10^{-4}$) [kgm ²]					
			 S44	P63	P71	 HS		
VF 44	VF 44_7	7	—	0.29	0.27	—	—	0.18
	VF 44_10	10	—	0.24	0.22	—	—	0.14
	VF 44_14	14	—	0.23	0.21	—	—	0.12
	VF 44_20	20	—	0.19	0.18	—	—	0.09
	VF 44_28	28	—	0.21	0.19	—	—	0.11
	VF 44_35	35	—	0.19	0.18	—	—	0.09
	VF 44_46	46	—	0.18	—	—	—	0.08
	VF 44_60	60	—	0.17	—	—	—	0.07
	VF 44_70	70	—	0.17	—	—	—	0.07
	VF 44_100	100	—	0.17	—	—	—	0.07
VFR 44	VFR 44_70	70	0.21	—	—	—	—	—
	VFR 44_100	100	0.20	—	—	—	—	—
	VFR 44_140	140	0.20	—	—	—	—	—
	VFR 44_175	175	0.20	—	—	—	—	—
	VFR 44_230	230	0.20	—	—	—	—	—
	VFR 44_300	300	0.20	—	—	—	—	—
	VFR 44_350	350	0.20	—	—	—	—	—
	VFR 44_500	500	0.20	—	—	—	—	—

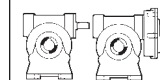

VF 49 - VFR 49

		i	J ($\cdot 10^{-4}$) [kgm ²]					
			P63	P71	  P80			 HS
VF 49	VF 49_7	7	0.69	0.67	0.61	—	—	0.42
	VF 49_10	10	0.61	0.60	0.53	—	—	0.34
	VF 49_14	14	0.58	0.57	0.5	—	—	0.31
	VF 49_18	18	0.54	0.53	0.46	—	—	0.27
	VF 49_24	24	0.52	0.5	0.44	—	—	0.24
	VF 49_28	28	0.56	0.54	0.48	—	—	0.28
	VF 49_36	36	0.53	0.51	—	—	—	0.25
	VF 49_45	45	0.51	0.49	—	—	—	0.24
	VF 49_60	60	0.50	0.48	—	—	—	0.23
	VF 49_70	70	0.50	—	—	—	—	0.22
	VF 49_80	80	0.49	—	—	—	—	0.22
VF 49_100	100	0.49	—	—	—	—	0.22	
VFR 49	VFR 49_30	30	0.74	—	—	—	—	0.94
	VFR 49_42	42	0.73	—	—	—	—	0.93
	VFR 49_54	54	0.73	—	—	—	—	0.93
	VFR 49_72	72	0.73	—	—	—	—	0.93
	VFR 49_84	84	0.73	—	—	—	—	0.93
	VFR 49_108	108	0.73	—	—	—	—	0.93
	VFR 49_135	135	0.73	—	—	—	—	0.93
	VFR 49_180	180	0.73	—	—	—	—	0.93
	VFR 49_210	210	0.72	—	—	—	—	0.92
	VFR 49_240	240	0.72	—	—	—	—	0.92
	VFR 49_300	300	0.72	—	—	—	—	0.92

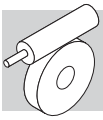



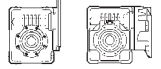
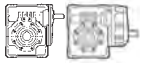

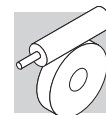

W 63 - WR 63

		i	J ($\cdot 10^{-4}$) [kgm ²]									
												
			S1	S2	S3	P63	P71	P80	P90			HS
W 63	W 63_7	7	3.4	3.6	—	—	3.5	3.5	3.5	—	—	3.6
	W 63_10	10	3.1	3.3	—	—	3.2	3.3	3.2	—	—	3.3
	W 63_12	12	3.1	3.3	—	—	3.1	3.2	3.1	—	—	3.3
	W 63_15	15	3.0	3.2	—	—	3.0	3.1	3.0	—	—	3.2
	W 63_19	19	2.9	3.1	—	—	2.9	3.0	2.9	—	—	3.1
	W 63_24	24	2.8	3.1	—	—	2.9	3.0	2.9	—	—	3.0
	W 63_30	30	2.9	3.1	—	—	2.9	3.0	2.9	—	—	3.1
	W 63_38	38	2.8	3.1	—	—	2.9	3.0	2.9	—	—	3.0
	W 63_45	45	2.8	3.0	—	—	2.9	2.9	2.9	—	—	3.0
	W 63_64	64	2.8	3.0	—	—	2.8	2.9	2.8	—	—	3.0
	W 63_80	80	2.8	3.0	—	—	2.8	2.9	2.8	—	—	3.0
W 63_100	100	2.8	3.0	—	—	2.8	2.9	2.8	—	—	2.9	
WR 63	WR 63_21	21	—	—	—	0.84	0.83	—	—	—	—	0.81
	WR 63_30	30	—	—	—	0.81	0.80	—	—	—	—	0.78
	WR 63_36	36	—	—	—	0.81	0.80	—	—	—	—	0.77
	WR 63_45	45	—	—	—	0.80	0.79	—	—	—	—	0.76
	WR 63_57	57	—	—	—	0.79	0.78	—	—	—	—	0.75
	WR 63_72	72	—	—	—	0.78	0.77	—	—	—	—	0.74
	WR 63_90	90	—	—	—	0.79	0.78	—	—	—	—	0.75
	WR 63_114	114	—	—	—	0.78	0.77	—	—	—	—	0.74
	WR 63_135	135	—	—	—	0.78	0.77	—	—	—	—	0.74
	WR 63_192	192	—	—	—	0.77	0.76	—	—	—	—	0.74
	WR 63_240	240	—	—	—	0.77	0.76	—	—	—	—	0.74
WR 63_300	300	—	—	—	0.77	0.76	—	—	—	—	0.73	

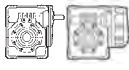

W 75 - WR 75

		i	J ($\cdot 10^{-4}$) [kgm ²]									
			 S1 S2 S3			     					 HS	
W 75	W 75_7	7	6.9	6.6	6.6	—	6.9	7.0	6.9	6.9	6.9	7.3
	W 75_10	10	6.4	6.1	6.1	—	6.4	6.4	6.3	5.7	5.7	6.8
	W 75_15	15	6.1	5.8	5.8	—	6.1	6.1	6.0	5.3	5.3	6.5
	W 75_20	20	5.9	5.6	5.6	—	5.9	5.9	5.9	5.2	5.2	6.3
	W 75_25	25	5.9	5.6	5.6	—	6.0	6.0	5.9	5.2	5.2	6.3
	W 75_30	30	5.9	5.6	5.6	—	5.9	5.9	5.9	5.2	5.2	6.3
	W 75_40	40	5.9	5.6	5.6	—	5.9	5.9	5.8	5.2	5.2	6.3
	W 75_50	50	5.9	5.6	5.6	—	5.9	5.9	5.8	5.1	5.1	6.2
	W 75_60	60	5.8	5.5	5.5	—	5.8	5.9	5.8	5.1	5.1	6.2
	W 75_80	80	5.8	5.5	5.5	—	5.8	5.8	5.8	5.1	5.1	6.2
W 75_100	100	5.8	5.5	5.5	—	5.8	5.8	5.7	5.0	5.0	6.2	

WR 75	WR 75_21	21	—	—	—	1.2	1.2	2.1	—	—	—	1.9
	WR 75_30	30	—	—	—	1.1	1.1	2.1	—	—	—	1.1
	WR 75_45	45	—	—	—	1.1	1.1	2.0	—	—	—	1.1
	WR 75_60	60	—	—	—	1.1	1.1	2.0	—	—	—	1.0
	WR 75_75	75	—	—	—	1.1	1.1	2.0	—	—	—	1.0
	WR 75_90	90	—	—	—	1.1	1.1	2.0	—	—	—	1.0
	WR 75_120	120	—	—	—	1.1	1.1	2.0	—	—	—	1.0
	WR 75_150	150	—	—	—	1.1	1.1	2.0	—	—	—	1.0
	WR 75_180	180	—	—	—	1.1	1.1	2.0	—	—	—	1.0
	WR 75_240	240	—	—	—	1.1	1.1	2.0	—	—	—	1.0
	WR 75_300	300	—	—	—	1.1	1.1	2.0	—	—	—	1.0

		J ($\cdot 10^{-4}$) [kgm ²]
i		 P90

WR 75_P90 B5	WR 75_15	15	6.0
	WR 75_22.5	22.5	5.9
	WR 75_30	30	5.8
	WR 75_37.5	37.5	5.8
	WR 75_45	45	5.8
	WR 75_60	60	5.8
	WR 75_75	75	5.8
	WR 75_90	90	5.7
	WR 75_120	120	5.7
	WR 75_150	150	5.7

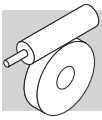

W 86 - WR 86

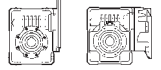
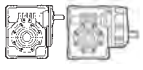
		i	J ($\cdot 10^{-4}$) [kgm ²]									
												
			S1	S2	S3	P63	P71	P80	P90	P100	HS	
W 86	W 86_7	7	9.7	9.4	9.4	—	9.7	9.7	9.6	9.6	—	10.1
	W 86_10	10	8.4	8.1	8.1	—	8.4	8.4	8.3	7.7	—	8.9
	W 86_15	15	7.7	7.4	7.4	—	7.7	7.7	7.7	7.0	—	8.2
	W 86_20	20	6.9	6.6	6.6	—	6.9	7.0	6.9	6.2	—	7.4
	W 86_23	23	6.8	6.5	6.5	—	6.8	6.9	6.8	6.1	—	7.3
	W 86_30	30	7.3	7.0	7.0	—	7.3	7.3	7.3	6.6	—	7.8
	W 86_40	40	6.7	6.4	6.4	—	6.7	6.7	6.6	6.0	—	7.2
	W 86_46	46	6.7	6.4	6.4	—	6.7	6.7	6.6	5.9	—	7.1
	W 86_56	56	6.6	6.3	6.3	—	6.6	6.7	6.6	5.9	—	7.1
	W 86_64	64	6.6	6.3	6.3	—	6.6	6.6	6.5	5.9	—	7.1
	W 86_80	80	6.6	6.3	6.3	—	6.6	6.6	6.5	5.9	—	7.1
	W 86_100	100	6.4	6.1	6.1	—	6.4	6.5	6.4	5.7	—	6.9

WR 86	WR 86_21	21	—	—	—	1.5	1.5	2.4	—	—	—	2.2
	WR 86_30	30	—	—	—	1.4	1.3	2.3	—	—	—	1.3
	WR 86_45	45	—	—	—	1.3	1.3	2.2	—	—	—	1.2
	WR 86_60	60	—	—	—	1.2	1.2	2.1	—	—	—	1.2
	WR 86_69	69	—	—	—	1.2	1.2	2.1	—	—	—	1.1
	WR 86_90	90	—	—	—	1.2	1.2	2.2	—	—	—	1.2
	WR 86_120	120	—	—	—	1.2	1.2	2.1	—	—	—	1.1
	WR 86_138	138	—	—	—	1.2	1.2	2.1	—	—	—	1.1
	WR 86_168	168	—	—	—	1.2	1.2	2.1	—	—	—	1.1
	WR 86_192	192	—	—	—	1.2	1.1	2.1	—	—	—	1.1
	WR 86_240	240	—	—	—	1.2	1.1	2.1	—	—	—	1.1
	WR 86_300	300	—	—	—	1.1	1.1	2.1	—	—	—	1.1

		J ($\cdot 10^{-4}$) [kgm ²]	
		i	 P90

WR 86_P90 B5	WR 86_15	15	6.9
	WR 86_22.5	22.5	6.6
	WR 86_30	30	6.3
	WR 86_34.5	34.5	6.2
	WR 86_45	45	6.4
	WR 86_60	60	6.2
	WR 86_69	69	6.1
	WR 86_84	84	6.1
	WR 86_96	96	6.0
	WR 86_120	120	6.0
WR 86_150	150	5.9	

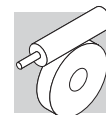

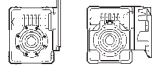
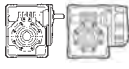

W 110 - WR 110

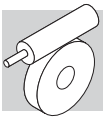
		i	J (•10 ⁻⁴) [kgm ²]									
												
			S1	S2	S3	P63	P71	P80	P90	P100	P132	HS
W 110	W 110_7	7	—	22	22	—	—	23	23	23	28	23
	W 110_10	10	—	19	19	—	—	19	19	24	24	20
	W 110_15	15	—	17	17	—	—	17	17	22	22	17
	W 110_20	20	—	14	14	—	—	14	14	19	19	15
	W 110_23	23	—	14	14	—	—	14	14	19	19	15
	W 110_30	30	—	15	15	—	—	16	16	20	20	16
	W 110_40	40	—	13	13	—	—	14	14	19	19	14
	W 110_46	46	—	13	13	—	—	13	13	18	18	14
	W 110_56	56	—	13	13	—	—	13	13	18	18	14
	W 110_64	64	—	13	13	—	—	13	13	18	18	14
	W 110_80	80	—	13	13	—	—	13	13	18	18	14
W 110_100	100	—	13	13	—	—	13	13	18	18	14	
WR 110	WR 110_21	21	—	—	—	—	3.0	9.0	8.8	8.9	—	9.2
	WR 110_30	30	—	—	—	—	2.5	8.6	8.4	8.4	—	8.8
	WR 110_45	45	—	—	—	—	2.3	8.3	8.2	8.2	—	8.5
	WR 110_60	60	—	—	—	—	2.0	8.1	7.9	7.9	—	8.3
	WR 110_69	69	—	—	—	—	2.0	8.0	7.9	7.9	—	8.2
	WR 110_90	90	—	—	—	—	2.2	8.2	8.1	8.1	—	8.4
	WR 110_120	120	—	—	—	—	1.9	8.0	7.8	7.9	—	8.2
	WR 110_138	138	—	—	—	—	1.9	8.0	7.8	7.8	—	8.2
	WR 110_168	168	—	—	—	—	1.9	8.0	7.8	7.8	—	8.1
	WR 110_192	192	—	—	—	—	1.9	7.9	7.8	7.8	—	8.1
	WR 110_240	240	—	—	—	—	1.9	7.9	7.8	7.8	—	8.1
WR 110_300	300	—	—	—	—	1.9	7.9	7.8	7.8	—	8.1	



VF 130 - VFR 130

		i	J ($\cdot 10^{-4}$) [kgm ²]					HS
			P80	P90	 P100	 P112	P132	
VF 130	VF 130_7	7	—	—	36	36	35	31
	VF 130_10	10	—	—	27	27	25	22
	VF 130_15	15	—	—	20	20	18	15
	VF 130_20	20	—	—	17	17	15	11
	VF 130_23	23	—	—	16	16	14	11
	VF 130_30	30	—	—	17	17	15	12
	VF 130_40	40	—	—	15	15	14	9.9
	VF 130_46	46	—	14	14	14	—	8.2
	VF 130_56	56	—	13	13	13	—	7.8
	VF 130_64	64	—	13	13	13	—	7.4
	VF 130_80	80	—	13	12	12	—	7.0
VF 130_100	100	—	13	—	—	—	8.9	
VFR 130	VFR 130_30	30	5.3	5.3	5.2	5.2	—	5.7
	VFR 130_45	45	4.5	4.5	4.4	4.4	—	4.9
	VFR 130_60	60	4.2	4.1	4.1	4.1	—	4.6
	VFR 130_69	69	4.1	4.0	4.0	4.0	—	4.5
	VFR 130_90	90	4.2	4.1	4.1	4.1	—	4.6
	VFR 130_120	120	4.0	3.9	4.0	4.0	—	4.4
	VFR 130_138	138	3.8	3.8	3.7	3.7	—	4.2
	VFR 130_168	168	3.8	3.7	3.7	3.7	—	4.1
	VFR 130_192	192	3.7	3.7	3.6	3.6	—	4.1
	VFR 130_240	240	3.7	3.6	3.6	3.6	—	4.1
	VFR 130_300	300	3.9	3.8	3.8	3.8	—	4.3

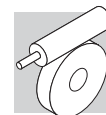

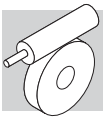

VF 150 - VFR 150

		i	J ($\cdot 10^{-4}$) [kgm ²]				
			P90	P100	P112	P132	HS
VF 150	VF 150_7	7	—	—	—	58	50
	VF 150_10	10	—	—	—	44	35
	VF 150_15	15	—	—	—	29	21
	VF 150_20	20	—	—	—	27	19
	VF 150_23	23	—	28	28	26	17
	VF 150_30	30	—	31	31	29	21
	VF 150_40	40	—	26	26	24	16
	VF 150_46	46	—	24	24	22	13
	VF 150_56	56	25	24	24	—	13
	VF 150_64	64	24	23	23	—	12
	VF 150_80	80	23	22	22	—	11
	VF 150_100	100	23	22	22	—	11
VFR 150	VFR 150_25	25	—	—	—	15	—
	VFR 150_30	30	10	10	10	—	11
	VFR 150_37.5	37.5	—	—	—	13	—
	VFR 150_45	45	8.8	8.8	8.8	—	9.7
	VFR 150_50	50	—	—	—	12	—
	VFR 150_60	60	8.3	8.3	8.3	—	9.2
	VFR 150_69	69	8.4	8.4	8.4	—	9.3
	VFR 150_90	90	8.7	8.7	8.7	—	9.7
	VFR 150_120	120	8.2	8.2	8.2	—	9.2
	VFR 150_138	138	7.9	7.9	7.9	—	8.9
	VFR 150_168	168	7.9	7.9	7.9	—	8.9
	VFR 150_192	192	7.8	7.8	7.8	—	8.8
	VFR 150_240	240	7.7	7.7	7.7	—	8.6
VFR 150_300	300	7.7	7.7	7.7	—	8.6	



VF 185 - VFR 185

		i	J ($\cdot 10^{-4}$) [kgm ²]						HS
			P90	P100	 P112	 P132	P160	P180	
VF 185	VF 185_7	7	—	—	—	—	—	146	128
	VF 185_10	10	—	—	—	—	—	108	91
	VF 185_15	15	—	—	—	—	70	88	50
	VF 185_20	20	—	—	—	—	69	66	48
	VF 185_30	30	—	—	—	58	54	—	34
	VF 185_40	40	—	—	—	63	61	—	41
	VF 185_50	50	—	59	59	58	—	—	35
	VF 185_60	60	—	55	55	53	—	—	31
	VF 185_80	80	—	52	52	51	—	—	28
	VF 185_100	100	—	51	51	—	—	—	27
VFR 185	VFR 185_25	25	—	—	—	24	—	—	—
	VFR 185_30	30	17	17	17	—	—	—	18
	VFR 185_37.5	37.5	—	—	—	17	—	—	—
	VFR 185_45	45	12	12	12	—	—	—	13
	VFR 185_50	50	—	—	—	17	—	—	—
	VFR 185_60	60	12	12	12	—	—	—	13
	VFR 185_75	75	—	—	—	15	—	—	—
	VFR 185_90	90	10	10	10	—	—	—	11
	VFR 185_100	100	—	—	—	16	—	—	—
	VFR 185_120	120	11	11	11	—	—	—	12
	VFR 185_150	150	10	10	10	—	—	—	11
	VFR 185_180	180	9.9	9.9	9.9	—	—	—	11
	VFR 185_240	240	9.6	9.6	9.6	—	—	—	11
VFR 185_300	300	9.5	9.4	9.4	—	—	—	10	

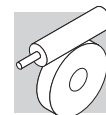

VF 210 - VFR 210

		i	J ($\cdot 10^{-4}$) [kgm ²]							HS
			P100	P112	P132	P160	P180	P200	P225	
VF 210	VF 210_7	7	—	—	286	286	286	286	286	286
	VF 210_10	10	—	—	177	177	177	177	177	177
	VF 210_15	15	—	—	120	120	120	120	120	120
	VF 210_20	20	—	—	116	116	116	116	116	116
	VF 210_30	30	—	—	81	81	81	81	81	81
	VF 210_40	40	—	—	98	98	98	98	98	98
	VF 210_50	50	—	—	84	84	84	84	84	84
	VF 210_60	60	—	—	75	75	75	75	75	75
	VF 210_80	80	—	—	68	68	68	68	68	68
	VF 210_100	100	—	—	63	63	63	63	63	63
VFR 210	VFR 210_30	30	48	48	47	47	—	—	—	51
	VFR 210_45	45	41	41	41	41	—	—	—	45
	VFR 210_60	60	41	41	41	40	—	—	—	45
	VFR 210_90	90	37	37	37	36	—	—	—	41
	VFR 210_120	120	39	39	39	38	—	—	—	43
	VFR 210_150	150	37	37	37	37	—	—	—	41
	VFR 210_180	180	36	36	36	36	—	—	—	40
	VFR 210_240	240	36	36	36	35	—	—	—	39
	VFR 210_300	300	35	35	35	34	—	—	—	39

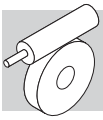

VF 250 - VFR 250

		i	J ($\cdot 10^{-4}$) [kgm ²]							
			P100	P112	P132	P160	P180	P200	P225	HS
VF 250	VF 250_7	7	—	—	620	620	620	620	620	620
	VF 250_10	10	—	—	387	387	387	387	387	387
	VF 250_15	15	—	—	266	266	266	266	266	266
	VF 250_20	20	—	—	242	242	242	242	242	242
	VF 250_30	30	—	—	184	184	184	184	184	184
	VF 250_40	40	—	—	241	241	241	241	241	241
	VF 250_50	50	—	—	240	240	240	240	240	240
	VF 250_60	60	—	—	158	158	158	158	158	158
	VF 250_80	80	—	—	160	160	160	160	160	160
	VF 250_100	100	—	—	149	149	149	149	149	149
VFR 250	VFR 250_30	30	71	71	71	70	—	—	—	75
	VFR 250_45	45	58	58	57	57	—	—	—	61
	VFR 250_60	60	55	55	55	54	—	—	—	58
	VFR 250_90	90	48	48	48	48	—	—	—	52
	VFR 250_120	120	55	55	54	54	—	—	—	58
	VFR 250_150	150	55	55	54	54	—	—	—	58
	VFR 250_180	180	46	46	45	45	—	—	—	49
	VFR 250_240	240	46	46	45	45	—	—	—	49
	VFR 250_300	300	45	45	44	44	—	—	—	48